

## Handout 3 (Automata)

Every formal language and compiler course I know of bombards you first with automata and then to a much, much smaller extent with regular expressions. As you can see, this course is turned upside down: regular expressions come first. The reason is that regular expressions are easier to reason about and the notion of derivatives, although already quite old, only became more widely known rather recently. Still let us in this lecture have a closer look at automata and their relation to regular expressions. This will help us with understanding why the regular expression matchers in Python, Ruby and Java are so slow with certain regular expressions. The central definition is:

A *deterministic finite automaton* (DFA), say  $A$ , is given by a four-tuple written  $A(Q, q_0, F, \delta)$  where

- $Q$  is a finite set of states,
- $q_0 \in Q$  is the start state,
- $F \subseteq Q$  are the accepting states, and
- $\delta$  is the transition function.

The transition function determines how to “transition” from one state to the next state with respect to a character. We have the assumption that these transition functions do not need to be defined everywhere: so it can be the case that given a character there is no next state, in which case we need to raise a kind of “failure exception”. A typical example of a DFA is

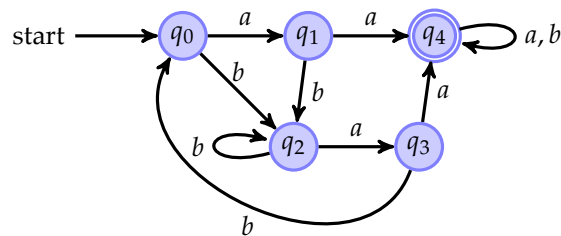

In this graphical notation, the accepting state  $q_4$  is indicated with double circles. Note that there can be more than one accepting state. It is also possible that a DFA has no accepting states at all, or that the starting state is also an accepting state. In the case above the transition function is defined everywhere and can be given as a table as follows:

---

© Christian Urban, King's College London, 2014, 2015, 2016, 2017

$(q_0, a)$	$\rightarrow$	$q_1$
$(q_0, b)$	$\rightarrow$	$q_2$
$(q_1, a)$	$\rightarrow$	$q_4$
$(q_1, b)$	$\rightarrow$	$q_2$
$(q_2, a)$	$\rightarrow$	$q_3$
$(q_2, b)$	$\rightarrow$	$q_2$
$(q_3, a)$	$\rightarrow$	$q_4$
$(q_3, b)$	$\rightarrow$	$q_0$
$(q_4, a)$	$\rightarrow$	$q_4$
$(q_4, b)$	$\rightarrow$	$q_4$

We need to define the notion of what language is accepted by an automaton. For this we lift the transition function  $\delta$  from characters to strings as follows:

$$\begin{aligned} \hat{\delta}(q, []) &\stackrel{\text{def}}{=} q \\ \hat{\delta}(q, c::s) &\stackrel{\text{def}}{=} \hat{\delta}(\delta(q, c), s) \end{aligned}$$

This lifted transition function is often called “delta-hat”. Given a string, we start in the starting state and take the first character of the string, follow to the next state, then take the second character and so on. Once the string is exhausted and we end up in an accepting state, then this string is accepted by the automaton. Otherwise it is not accepted. This also means that if along the way we hit the case where the transition function  $\delta$  is not defined, we need to raise an error. In our implementation we will deal with this case elegantly by using Scala’s Try. So  $s$  is in the *language accepted by the automaton*  $A(Q, q_0, F, \delta)$  iff

$$\hat{\delta}(q_0, s) \in F$$

I let you think about a definition that describes the set of strings accepted by an automaton.

A simple Scala implementation of DFAs is given in Figure 1. As you can see, there many features of the mathematical definition that are quite closely reflected in the code. In the `DFA`-class, there is a starting state, called `start`, with the polymorphic type `A`. There is a partial function `delta` for specifying the transitions. I used partial functions for transitions in Scala; alternatives would have been `Maps` or even `Lists`. One of the main advantages of using partial functions is that transitions can be quite nicely defined by a series of `case` statements (see Lines 28 – 38). If you need to represent an automaton with a sink state (catch-all-state), you can write something like

```

1 // DFAs in Scala based on partial functions
2 import scala.util.Try
3
4 // type abbreviation for partial functions
5 type :=>[A, B] = PartialFunction[A, B]
6
7 case class DFA[A, C](start: A,           // starting state
8                      delta: (A, C) :=> A, // transition partial fun
9                      fins: A => Boolean) { // final states
10
11   def deltas(q: A, s: List[C]) : A = s match {
12     case Nil => q
13     case c::cs => deltas(delta(q, c), cs)
14   }
15
16   def accepts(s: List[C]) : Boolean =
17     Try(fins(deltas(start, s))) getOrElse false
18 }
19
20 // the example shown earlier in the handout
21 abstract class State
22 case object Q0 extends State
23 case object Q1 extends State
24 case object Q2 extends State
25 case object Q3 extends State
26 case object Q4 extends State
27
28 val delta : (State, Char) :=> State =
29   { case (Q0, 'a') => Q1
30     case (Q0, 'b') => Q2
31     case (Q1, 'a') => Q4
32     case (Q1, 'b') => Q2
33     case (Q2, 'a') => Q3
34     case (Q2, 'b') => Q2
35     case (Q3, 'a') => Q4
36     case (Q3, 'b') => Q0
37     case (Q4, 'a') => Q4
38     case (Q4, 'b') => Q4 }
39
40 val dfa = DFA(Q0, delta, Set[State](Q4))
41
42 dfa.accepts("bbabaab".toList) // true
43 dfa.accepts("baba".toList)    // false

```

Figure 1: Scala implementation of DFAs using partial functions. Notice some subtleties: `deltas` implements the delta-hat construction by lifting the transition (partial) function to lists of Characters. Since `delta` is given as partial function, it can obviously go “wrong” in which case the `Try` in `accepts` catches the error and returns `false`, that is the string is not accepted. The example implements the DFA example shown above.

```

abstract class State
...
case object Sink extends State

val delta : (State, Char) => State =
{ case (S0, 'a') => S1
  case (S1, 'a') => S2
  case _ => Sink
}

```

The DFA-class has also an argument for final states. It is a function from states to booleans (returns true whenever a state is meant to be final; false otherwise). While this is a boolean function, Scala allows me to use sets of states for such functions (see Line 40 where I initialise the DFA).

I let you ponder whether this is a good implementation of DFAs. In doing so I hope you notice that the  $Q$  component (the set of finite states) is missing from the class definition. This means that the implementation allows you to do some fishy things you are not meant to do with DFAs. Which fishy things could that be?

While with DFAs it will always be clear that given a character what the next state is (potentially none), it will be useful to relax this restriction. That means we have several potential successor states. We even allow more than one starting state. The resulting construction is called a *non-deterministic finite automaton* (NFA) given also as a four-tuple  $A(Q, Q_{0s}, F, \rho)$  where

- $Q$  is a finite set of states
- $Q_{0s}$  are the start states ( $Q_{0s} \subseteq Q$ )
- $F$  are some accepting states with  $F \subseteq Q$ , and
- $\rho$  is a transition relation.

Two typical examples of NFAs are

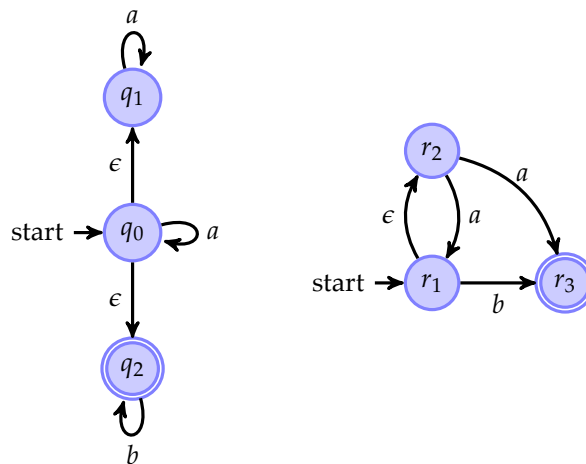

There are, however, a number of points you should note. Every DFA is a NFA, but not vice versa. The  $\rho$  in NFAs is a transition *relation* (DFAs have a transition function). The difference between a function and a relation is that a function has always a single output, while a relation gives, roughly speaking, several outputs. Look at the NFA on the right-hand side above: if you are currently in the state  $r_2$  and you read a character  $a$ , then you can transition to either  $r_1$  or  $r_3$ . Which route you take is not determined. This means if we need to decide whether a string is accepted by a NFA, we might have to explore all possibilities. Also there is the special silent transition in NFAs. As mentioned already this transition means you do not have to “consume” any part of the input string, but “silently” change to a different state. In the left picture, for example, if you are in the starting state, you can silently move either to  $q_1$  or  $q_2$ . This silent transition is also often called  $\epsilon$ -transition.

### Thompson Construction

The reason for introducing NFAs is that there is a relatively simple (recursive) translation of regular expressions into NFAs. Consider the simple regular expressions  $0$ ,  $1$  and  $c$ . They can be translated as follows:

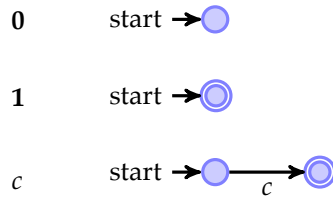

The case for the sequence regular expression  $r_1 \cdot r_2$  is as follows: We are given by recursion two automata representing  $r_1$  and  $r_2$  respectively.

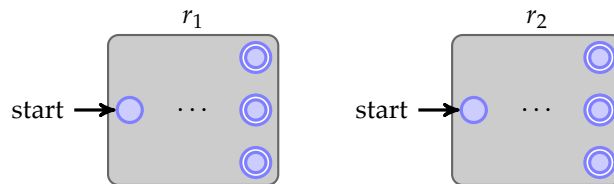

The first automaton has some accepting states. We obtain an automaton for  $r_1 \cdot r_2$  by connecting these accepting states with  $\epsilon$ -transitions to the starting state of the second automaton. By doing so we make them non-accepting like so:

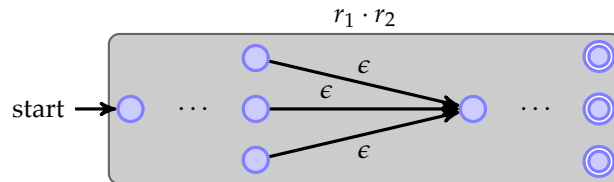

The case for the choice regular expression  $r_1 + r_2$  is slightly different: We are given by recursion two automata representing  $r_1$  and  $r_2$  respectively.

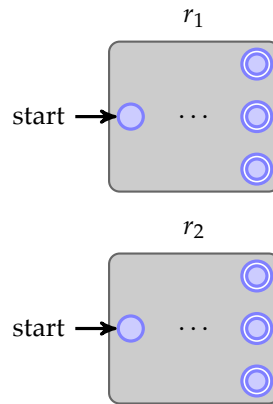

Each automaton has a single start state and potentially several accepting states. We obtain a NFA for the regular expression  $r_1 + r_2$  by introducing a new starting state and connecting it with an  $\epsilon$ -transition to the two starting states above, like so

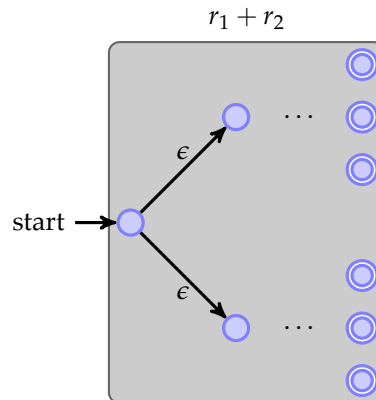

Finally for the \*-case we have an automaton for  $r$

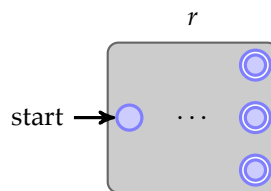

and connect its accepting states to a new starting state via  $\epsilon$ -transitions. This new starting state is also an accepting state, because  $r^*$  can recognise the empty string. This gives the following automaton for  $r^*$ :

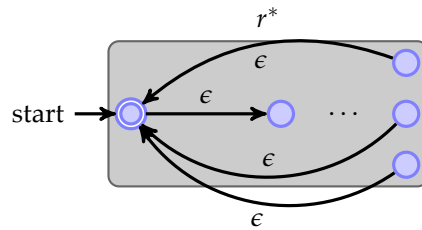

This construction of a NFA from a regular expression was invented by Ken Thompson in 1968.

### Subset Construction

What is interesting is that for every NFA we can find a DFA which recognises the same language. This can, for example, be done by the *subset construction*. Consider again the NFA below on the left, consisting of nodes labeled 0, 1 and 2.

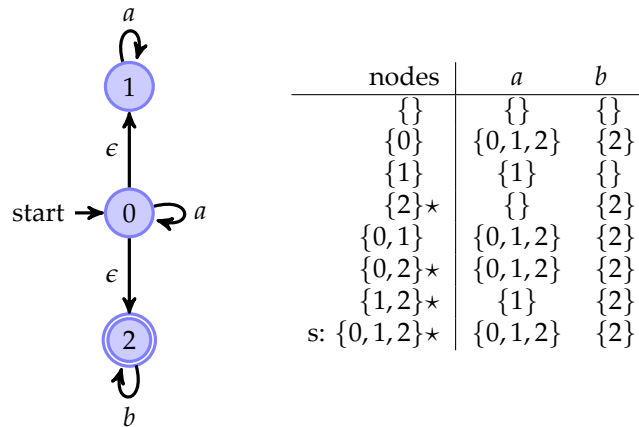

The nodes of the DFA are given by calculating all subsets of the set of nodes of the NFA (seen in the nodes column on the right). The table shows the transition function for the DFA. The first row states that {} is the sink node which has transitions for a and b to itself. The next three lines are calculated as follows:

- suppose you calculate the entry for the transition for a and the node {0}
- start from the node 0 in the NFA
- do as many  $\epsilon$ -transition as you can obtaining a set of nodes, in this case {0, 1, 2}
- filter out all nodes that do not allow an a-transition from this set, this excludes 2 which does not permit a a-transition

- from the remaining set, do as many  $\epsilon$ -transition as you can, this yields again  $\{0, 1, 2\}$
- the resulting set specifies the transition from  $\{0\}$  when given an  $a$

So the transition from the state  $\{0\}$  reading an  $a$  goes to the state  $\{0, 1, 2\}$ . Similarly for the other entries in the rows for  $\{0\}$ ,  $\{1\}$  and  $\{2\}$ . The other rows are calculated by just taking the union of the single node entries. For example for  $a$  and  $\{0, 1\}$  we need to take the union of  $\{0, 1, 2\}$  (for 0) and  $\{1\}$  (for 1). The starting state of the DFA can be calculated from the starting state of the NFA, that is 0, and then do as many  $\epsilon$ -transitions as possible. This gives  $\{0, 1, 2\}$  which is the starting state of the DFA. The terminal states in the DFA are given by all sets that contain a 2, which is the terminal state of the NFA. This completes the subset construction. So the corresponding DFA to the NFA from above is

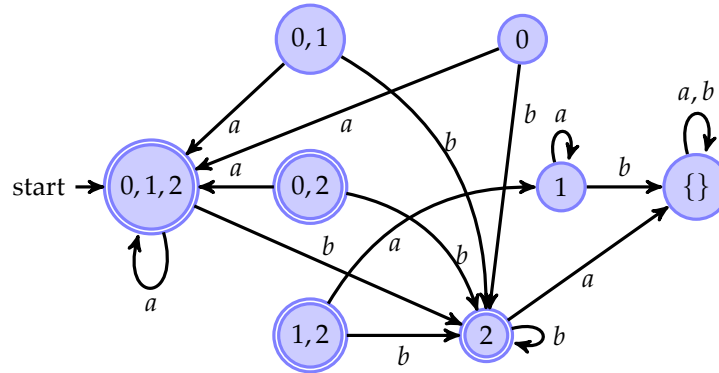

There are two points to note: One is that very often the resulting DFA contains a number of “dead” nodes that are never reachable from the starting state. For example there is no way to reach node  $\{0, 2\}$  from the starting state  $\{0, 1, 2\}$ . I let you find the other dead states. In effect the DFA in this example is not a minimal DFA. Such dead nodes can be safely removed without changing the language that is recognised by the DFA. Another point is that in some cases, however, the subset construction produces a DFA that does *not* contain any dead nodes...that means it calculates a minimal DFA. Which in turn means that in some cases the number of nodes by going from NFAs to DFAs exponentially increases, namely by  $2^n$  (which is the number of subsets you can form for  $n$  nodes).

Removing all the dead states in the automaton above, gives a much more legible automaton, namely



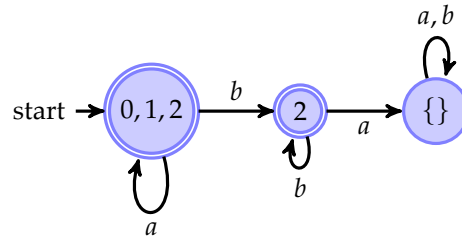

Now the big question is whether this DFA can recognise the same language as the NFA we started with. I let you ponder about this question.

### Brzozowski's Method

As said before, we can also go into the other direction—from DFAs to regular expressions. Brzozowski's method calculates a regular expression using familiar transformations for solving equational systems. Consider the DFA:

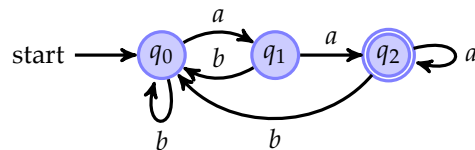

for which we can set up the following equational system

$$q_0 = \mathbf{1} + q_0 b + q_1 b + q_2 b \quad (1)$$

$$q_1 = q_0 a \quad (2)$$

$$q_2 = q_1 a + q_2 a \quad (3)$$

There is an equation for each node in the DFA. Let us have a look how the right-hand sides of the equations are constructed. First have a look at the second equation: the left-hand side is  $q_1$  and the right-hand side  $q_0 a$ . The right-hand side is essentially all possible ways how to end up in node  $q_1$ . There is only one incoming edge from  $q_0$  consuming an  $a$ . Therefore the right hand side is this state followed by character—in this case  $q_0 a$ . Now lets have a look at the third equation: there are two incoming edges for  $q_2$ . Therefore we have two terms, namely  $q_1 a$  and  $q_2 a$ . These terms are separated by  $+$ . The first states that if in state  $q_1$  consuming an  $a$  will bring you to  $q_2$ , and the second that being in  $q_2$  and consuming an  $a$  will make you stay in  $q_2$ . The right-hand side of the first equation is constructed similarly: there are three incoming edges, therefore there are three terms. There is one exception in that we also "add"  $\mathbf{1}$  to the first equation, because it corresponds to the starting state in the DFA.

Having constructed the equational system, the question is how to solve it? Remarkably the rules are very similar to solving usual linear equational systems. For example the second equation does not contain the variable  $q_1$  on the

right-hand side of the equation. We can therefore eliminate  $q_1$  from the system by just substituting this equation into the other two. This gives

$$q_0 = \mathbf{1} + q_0 b + q_0 a b + q_2 b \quad (4)$$

$$q_2 = q_0 a a + q_2 a \quad (5)$$

where in Equation (4) we have two occurrences of  $q_0$ . Like the laws about  $+$  and  $\cdot$ , we can simplify Equation (4) to obtain the following two equations:

$$q_0 = \mathbf{1} + q_0 (b + a b) + q_2 b \quad (6)$$

$$q_2 = q_0 a a + q_2 a \quad (7)$$

Unfortunately we cannot make any more progress with substituting equations, because both (6) and (7) contain the variable on the left-hand side also on the right-hand side. Here we need to now use a law that is different from the usual laws about linear equations. It is called *Arden's rule*. It states that if an equation is of the form  $q = q r + s$  then it can be transformed to  $q = s r^*$ . Since we can assume  $+$  is symmetric, Equation (7) is of that form:  $s$  is  $q_0 a a$  and  $r$  is  $a$ . That means we can transform (7) to obtain the two new equations

$$q_0 = \mathbf{1} + q_0 (b + a b) + q_2 b \quad (8)$$

$$q_2 = q_0 a a (a^*) \quad (9)$$

Now again we can substitute the second equation into the first in order to eliminate the variable  $q_2$ .

$$q_0 = \mathbf{1} + q_0 (b + a b) + q_0 a a (a^*) b \quad (10)$$

Pulling  $q_0$  out as a single factor gives:

$$q_0 = \mathbf{1} + q_0 (b + a b + a a (a^*) b) \quad (11)$$

This equation is again of the form so that we can apply Arden's rule ( $r$  is  $b + a b + a a (a^*) b$  and  $s$  is  $\mathbf{1}$ ). This gives as solution for  $q_0$  the following regular expression:

$$q_0 = \mathbf{1} (b + a b + a a (a^*) b)^* \quad (12)$$

Since this is a regular expression, we can simplify away the  $\mathbf{1}$  to obtain the slightly simpler regular expression

$$q_0 = (b + a b + a a (a^*) b)^* \quad (13)$$

Now we can unwind this process and obtain the solutions for the other equations. This gives:

$$q_0 = (b + a b + a a (a^*) b)^* \quad (14)$$

$$q_1 = (b + a b + a a (a^*) b)^* a \quad (15)$$

$$q_2 = (b + a b + a a (a^*) b)^* a a (a)^* \quad (16)$$

Finally, we only need to “add” up the equations which correspond to a terminal state. In our running example, this is just  $q_2$ . Consequently, a regular expression that recognises the same language as the automaton is

$$(b + a b + a a (a^*) b)^* a a (a)^*$$

You can somewhat crosscheck your solution by taking a string the regular expression can match and see whether it can be matched by the automaton. One string for example is  $aaa$  and *voila* this string is also matched by the automaton.

We should prove that Brzozowski’s method really produces an equivalent regular expression for the automaton. But for the purposes of this module, we omit this.

### Automata Minimization

As seen in the subset construction, the translation of an NFA to a DFA can result in a rather “inefficient” DFA. Meaning there are states that are not needed. A DFA can be *minimised* by the following algorithm:

1. Take all pairs  $(q, p)$  with  $q \neq p$
2. Mark all pairs that accepting and non-accepting states
3. For all unmarked pairs  $(q, p)$  and all characters  $c$  test whether

$$(\delta(q, c), \delta(p, c))$$

are marked. If there is one, then also mark  $(q, p)$ .

4. Repeat last step until no change.
5. All unmarked pairs can be merged.

To illustrate this algorithm, consider the following DFA.

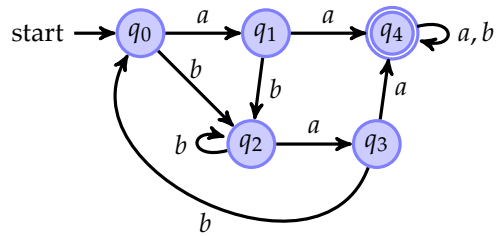

In Step 1 and 2 we consider essentially a triangle of the form

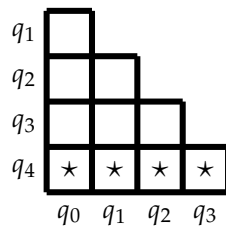

where the lower row is filled with stars, because in the corresponding pairs there is always one state that is accepting ( $q_4$ ) and a state that is non-accepting (the other states).

Now in Step 3 we need to fill in more stars according to whether one of the next-state pairs are marked. We have to do this for every unmarked field until there is no change anymore. This gives the triangle

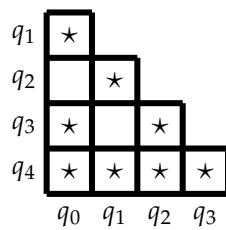

which means states  $q_0$  and  $q_2$ , as well as  $q_1$  and  $q_3$  can be merged. This gives the following minimal DFA

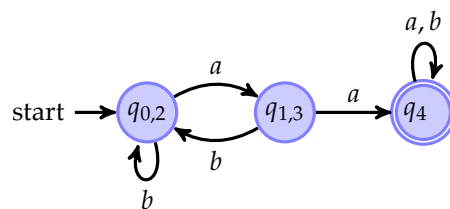

## Regular Languages

Given the constructions in the previous sections we obtain the following overall picture:

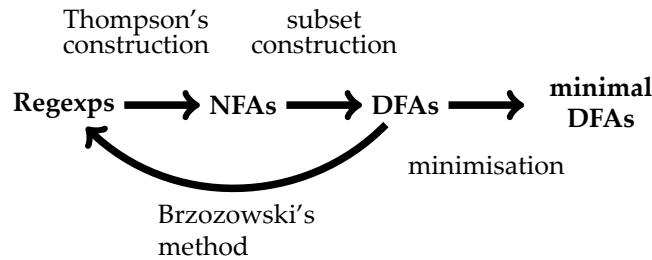

By going from regular expressions over NFAs to DFAs, we can always ensure that for every regular expression there exists a NFA and a DFA that can recognise the same language. Although we did not prove this fact. Similarly by going from DFAs to regular expressions, we can make sure for every DFA there exists a regular expression that can recognise the same language. Again we did not prove this fact.

The interesting conclusion is that automata and regular expressions can recognise the same set of languages:

A language is *regular* iff there exists a regular expression that recognises all its strings.

or equivalently

A language is *regular* iff there exists an automaton that recognises all its strings.

So for deciding whether a string is recognised by a regular expression, we could use our algorithm based on derivatives or NFAs or DFAs. But let us quickly look at what the differences mean in computational terms. Translating a regular expression into a NFA gives us an automaton that has  $O(n)$  nodes—that means the size of the NFA grows linearly with the size of the regular expression. The problem with NFAs is that the problem of deciding whether a string is accepted or not is computationally not cheap. Remember with NFAs we have potentially many next states even for the same input and also have the silent  $\epsilon$ -transitions. If we want to find a path from the starting state of an NFA to an accepting state, we need to consider all possibilities. In Ruby and Python this is done by a depth-first search, which in turn means that if a “wrong” choice is made, the algorithm has to backtrack and thus explore all potential candidates. This is exactly the reason why Ruby and Python are so slow for evil regular expressions. An alternative to the potentially slow depth-first search is to explore the search space in a breadth-first fashion, but this might incur a big memory penalty.

To avoid the problems with NFAs, we can translate them into DFAs. With DFAs the problem of deciding whether a string is recognised or not is much simpler, because in each state it is completely determined what the next state will be for a given input. So no search is needed. The problem with this is that the translation to DFAs can explode exponentially the number of states. Therefore when this route is taken, we definitely need to minimise the resulting DFAs in order to have an acceptable memory and runtime behaviour. But remember the subset construction in the worst case explodes the number of states by  $2^n$ . Effectively also the translation to DFAs can incur a big runtime penalty.

But this does not mean that everything is bad with automata. Recall the problem of finding a regular expressions for the language that is *not* recognised by a regular expression. In our implementation we added explicitly such a regular expressions because they are useful for recognising comments. But in principle we did not need to. The argument for this is as follows: take a regular expression, translate it into a NFA and then a DFA that both recognise the same language. Once you have the DFA it is very easy to construct the automaton for the language not recognised by an DFA. If the DFA is completed (this is important!), then you just need to exchange the accepting and non-accepting states. You can then translate this DFA back into a regular expression and that will be the regular expression that can match all strings the original regular expression could *not* match.

It is also interesting that not all languages are regular. The most well-known example of a language that is not regular consists of all the strings of the form

$$a^n b^n$$

meaning strings that have the same number of *as* and *bs*. You can try, but you cannot find a regular expression for this language and also not an automaton. One can actually prove that there is no regular expression nor automaton for this language, but again that would lead us too far afield for what we want to do in this module.

## Further Reading

Compare what a “human expert” would create as an automaton for the regular expression  $a(b + c)^*$  and what the Thomson algorithm generates.